

Double Disc Anchor with 4" & 6" Disc



Shaft: 3/4", Length: 36",
Discs: 6" & 4"

Recommended for Soil Class 4

0120019 6/Bundle; 180/Skid

0121019 6/Bundle; 180/Skid,
Galvanized



0120019

Single Disc Anchors



Earth anchor with disc and double fastening and tensioning head.

Recommended for Soil Class 4

With 6" Disc

0120000 48" L, 5/8" Shaft; 6/Bundle, 180/Skid

0120003 48" L, 3/4" Shaft; 6/Bundle, 180/Skid

0120001 36" L, 3/4" Shaft; 6/Bundle, 180/Skid

With 8" Disc

0120020 60" L, 3/4" Shaft; Each

Galvanized Single Disc

0120400 48" L, 5/8" Shaft Galv., 6" Disc, 6/Bdl.

0120401 48" L, 3/4" Shaft Galv., 6" Disc, 6/Bundle, 180/Skid

0120402 60" L, 3/4" Shaft Galv., 8" Disc, 6/Bundle, 180/Skid



0120003

ZipCap Anchor Stabilizer



Easy to install; screws into ground with anchor when you use a ZIPCAP adapter. Saves money; you don't need to stock two types of anchors. Saves space; packaged 8 to a box for easy transport. Better performance; free-floating ZIPCAP doesn't move when anchor pulls vertically.

More flexibility; approved for soil class 2 & 3 with 0120004 and soil class 4 with 0120019.

0120050 HP34 & HP3 3/4" x 30" Anchor, 4" Discs,
150/Skid (F/Class 3)

0120051 HP34 & HP17 3/4" x 36" Anchor, 6" Discs,
110/Skid (F/Class 4)

0120029 Electric Anchor Adapter for Zip Cap



0120050

Double Disc Anchors



Double 4" disc earth anchor with double fastening and tensioning head for use with straps. Designed to be augured into extremely hard soil where 6" disc anchor will not suffice. Two 4" discs. 200/Skid; 8/Bundle.

Recommended for Soil Classes 2 & 3

0120004 30" L, 3/4" Shaft;
8/Bundle, 200/Skid

0121004 Same as 0120004,
but Galvanized

0120008 30" L, 5/8" Shaft;
8/Bundle, 200/Skid

0120011 48" L, 3/4" Shaft

0120012 42" L, 3/4" Shaft

0121012 Same as 0120012, but Galvanized



0120004

Minute Man anchors, Inc.

E-Z Anchors

Save time and money with one-step stabilized anchors for decks and steps. Easy to install, needs no concrete. Built-in stabilizer head and compacting disk, pitched dual blades. **Approved for use in Alabama for Class 3 Soil.**

0120025 3/4" Shaft, 30" L 4430
36" with 4" and 6" disks,
150/Skid

0120023 36" w/ 4" and 6" disks

Not stocked at all locations



Cross Drive Anchors

Drive anchor with fastening and tensioning head, 3/4" shafts. Welded tubing guides the two 48" long drive rods. Designed to be driven into solid rock. 200/Skid; 4/Box.

Recommended for
Soil Class 1/Solid Rock

0120002 48" Long

0120010 36" Long

0120017 Head Only

0120048 36" Rod Only



ZipCap



0120028 HP34 ZIPCAP only, 8/Bdl.

Minute Man anchors,™

GW-2 Anchor

Nu Concept Anchor includes:

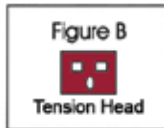
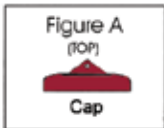

0120022 GW-2 Soil Anchor

0121022 GW-2 Soil Anchor, Galvanized

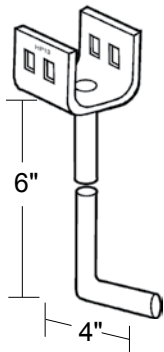

Patio Slab Anchors

Patio slab hooked rod attachment with fastening and tensioning head installed when pouring concrete slab. 16/Box



- 0120007** "L" Anchor
- 0121007** "L" Anchor, Galvanized
- 0120005** "J" Anchor w/Swivel Head
- 0121005** "J" Anchor w/Swivel Head, Galv.

Anchor Head With Sleeve

Use with wet concrete.

0120334
1-Pc. Unit
(Head w/Bolt
and Sleeve)

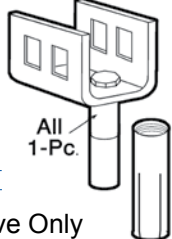

0120015 Sleeve Only

Solid Eye Adaptor

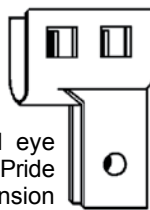

Adaptor for solid eye anchor with Home Pride fastening and tension head.

0120209 24/Ctn.

Anchor Head With Lag Bolt

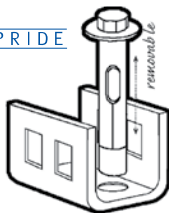

0120009 2-Pc. Unit; 32/Box
0121009 Galvanized; 32/Box

Double tensioning device for use on dry concrete or existing concrete slabs. 48/Ctn.

0120014 Head Only
0121014 Head Only - Galvanized
0120018 5/8" Lag Bolt Only

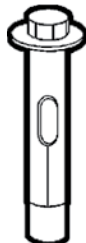

Anchor Bolt & Nut



Knurled bolt increases friction between strap and bolt shaft for greater strength than smooth bolts. Slotted for use with strap. Not included with anchor.



0120006 400/Keg, 8/bag

B-2

M-Plate Stabilizer



- More cutting points for better balance
- Smaller and shorter plate is easier to get into ground.
- "Power Ridge" provides extra strength for as much or more resistance than traditional plates
- More resistance concentrated at the top of the anchor, so plate performs as good or better than traditional plates even though it is smaller
- Meets all state requirements except FL, so can replace traditional stabilizer plates
- Average installation in 1/3 the time of traditional plates

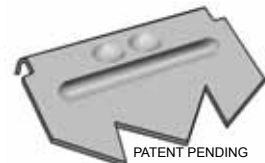

PATENT PENDING

0120188 7"H x 12"W M-Plate, 8/Box

0121188 7"H x 12"W M-Plate 8/Box, Galvanized

Anchor Stabilizing Device



Prevents anchors from becoming loose by cutting through the soil when heavy winds occur.
Required in most anchor installations.

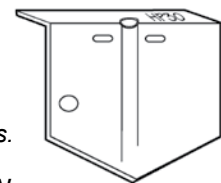

0120180 Stabilizer 12"H x 12"W

0121180 Stabilizer 12"H x 12"W, Galvanized

Stabilizer Plate



ABS Lateral Stabilizer Plate, Designed for loose soil conditions. 10" x 24" Class 4B Fla.; 6/Bdl.

0120186

Stabilizer Plate

Wind Zones 2 & 3



ABS Stabilizer Plate 1055-19

0120181

Speed Wrench

No more scraped up hands!

One handed operation tightens bolt & strap at the same time. 15/16" impact socket on one side and a 15/16" nut on the other. Combine with your own ratchet and 15/16" socket, and you have the fastest way to tighten slotted bolts.

0380107



Double Buckle w/8' Strap

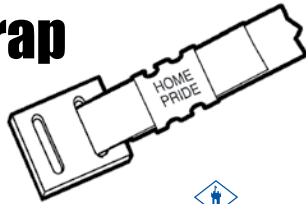

0120296 Box
0120297 Bulk



Single Buckle with Strap

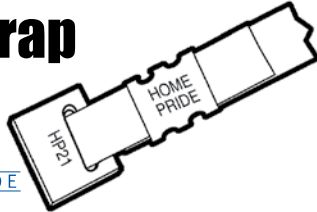

Galvanized strap with single buckle for fastening around home frame. 4/Bdl.

- 0120290 w/7' L Strap; Boxed; 48/Ctn.
- 0120308 w/7' L Strap; Bulk
- 0120275 w/8' L Strap; Boxed; 48/Ctn.
- 0120295 w/8' L Strap; Bulk
- 0120291 w/10' L Strap; Boxed; 32/Ctn.
- 0120292 w/10' L Strap; Bulk
- 0120294 w/15' L Strap; Bulk

Strap Buckle

Steel strap buckle for use in fastening strap around frame of mobile home.



- 0120311 2-Slot Buckle; 200/Bx
- 0120314 2-Slot Buckle; Each
- 0120300 1-Slot Buckle; Each

Strap Protector

Attaches between strap and I-beam to prevent cutting or breaking.

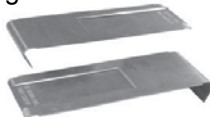

0120283

Strap Seal Crimping Tool

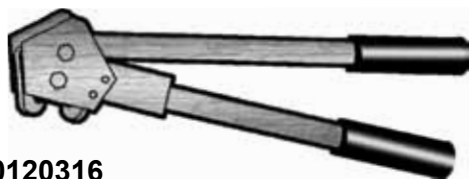

0120316

7' Column Tie-Down

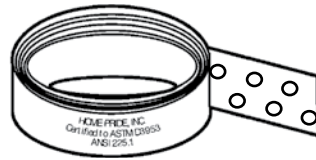

For marriage wall columns where opening is 48" or larger. Fasten to the column above the normal up-lift straps or to block with 13#8 1-1/4" screws (minimum).

0120435 HP38

Frame Clamp II with Strap

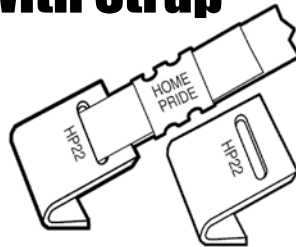

Frame clamp with strap for fastening around bottom flange of home frame. 4/Bdl.

- 0120313 Clamp II Only; 24/Ctn.
- 0120324 w/6' L Strap; Bulk
- 0120325 w/7' L Strap; 48/Box
- 0120329 w/7' L Strap; Bulk
- 0120330 w/8' L Strap; Bulk
- 0120276 w/8' L Strap; 48/Box
- 0120326 w/10' L Strap; 32/Box
- 0120348 w/10' L Strap; Bulk
- 0120312 w/12' L Strap; Bulk
- 0120331 w/12' L Strap; 32/Box
- 0120327 w/15' L Strap; 32/Box
- 0120328 w/15' L Strap; Bulk

Strap with Quick Connector



- 0120380 6' Strap with Small Connector Hole
- 0120384 7' Strap with Large Connector Hole
- 0120383 5' G120 Strap with Large Connector Hole (F1 Approved)

Anchor Strap



1-1/4" wide (with standard galvanized coating) strapping exceeds 4,725 lbs. breaking strength. (100 lb. roll: approx. 650'.)

- 0120301 37' L Roll, G-60; 12/Ctn.
- 0120307 100 lb. Roll, G-60

Same as above but with galvanized coating, approved for Florida.

- 0120431 37' L Roll, G120; 12/Ctn.
- 0120430 100 lb. Roll, G120

Strap Seal

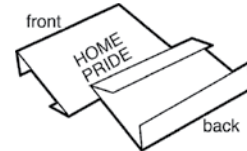

Secures strapping together with buckles or frame clamps. Must use strap seal crimping tool (120316). 300/Ctn.

0120299

Strap Connector

Universal Swivel/
Sidewall Connector
w/G120 Strap



- 0120417 Galvanized Strap; 6'
- 0120482 Galvanized Strap; 8'

Roof Bracket

Use for cable or strap passing over the mobile home. Holds straps or cable away from roof and sides. 100/Ctn. (Black steel, not galvanized.)



0120302 6", 24/Box

0120304 L-Bracket for Hurricane Strap

Beam Hooks

Use with swivel frame connectors for attaching anchor straps to I-beams.



0120406 3", 24/Box

0120407 4", 24/Box

0120408 Double, 24/Box

Not stocked at all locations

Swivel Connector with Strap

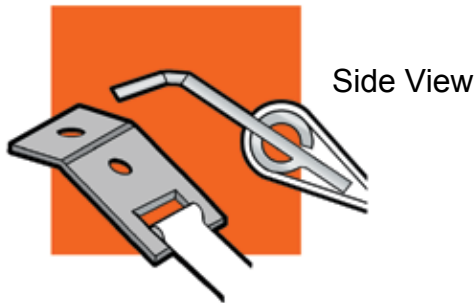

Factory attached strap for applications where use of standard frame ties is prohibited. To be used with beam hook. 4 per box. (Not stocked at all locations)

0120415 5' L Strap with Swivel Connector, 400/Skid

0120481 6' L Strap with Swivel Connector, 400/Skid

0120404 7' L Strap with Swivel Connector, 400/Skid

0120405 10' L Strap with Swivel Connector, 400/Skid

0120416 12' L Strap with Swivel Connector, 200/Skid

Longitudinal Frame Tie (4 Bolt)

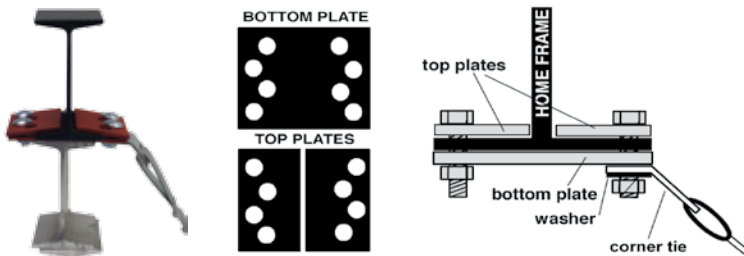

Use outside holes for 3-1/2" to 4" flanges; use inside holes for 2" to 3" flanges. For Wind Zone 1. 4 1/2" x 1-1/2" Grade 5 machine bolts and 8 1/2" high strength washers included.

0120420 MMA34/2822

Minute Man anchors, Inc.

Corner Tie With 7' Strap

0120421 2709, 400/Skid

Minute Man anchors, Inc.

Angle Bracket

Use with swivel frame connectors for attaching anchor straps to I-beams.

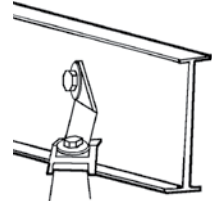

0120409 HP24, 24/Box

0120418 Replacement Nut and Bolt, 50/Box

Not stocked at all locations

Gator Clamp

(Longitudinal Beam Clamp)

Use with swivel frame connectors for attaching anchor straps to I-beams.

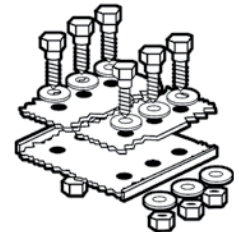

0120410 HP28, 4/Pk

Not stocked at all locations

Stable Safe Tie Downs

- Anchors solidly against wind to concrete foundations
- Eliminates motion caused by wind or occupant movement
- No hurricane straps are required
- Takes only minutes to install
- Adjusts in seconds to the exact height
- Requires no maintenance
- Install when concrete is being poured
- 16/Box



0120333

Vinyl Coated, Galvanized Cable

Heavy duty, ABS Molded Plastic Cable;
 Size: 1/8 x 3/16"; Const.: 7x7
 B.S. lbs.: 1700;
 S.W.L. Lbs.: 340
 Wt.: 20.1; Spool: 6"



0120470 500' L

Electric Anchor Machine



Features 12 RPM, 1/2 HP, 115 volt, 6 cycle, 9 amp motor, on-off, forward-reverse switches. With its 12 RPMs, it far outpaces any 6- or 9-RPM units. When running off a generator, a minimum of 4500 watts is required.

- 0120315** Reversing Switch
- 0120317** Anchor Adapter Only
- 0120318** On-Off Replacement Switch
- 0120319** Electric Anchor Machine Only



Anchors may be effectively and safely installed manually, but the electric auger machine will make the job easier and faster. Remember, however, that this method of installation requires two people.

Always make sure to avoid underground water, phone and power lines.

Attach the anchor to drive machine. Line up the auger with the strap and start machine. Install anchor at a slight angle (12° - 15°) underneath the house. This will ensure that the head of the anchor will be concealed behind future skirting.

RIDGID 700 Portable Power Drive



Heavy-duty hand-held power drive. Features reversible 115V or 230V universal motor. Horsepower: 1/2; RPM: 32; Weight: 25 lbs.; 115 AC. All shafts are ball-bearing mounted. Gears are packed in grease. Spring-loaded adapted pawls with forged steel spindle gear. No load: 7.5 amps, 750 watts With load: 18.0 amps, 1750 watts. Includes: drive, metal carrying case, attachment handle, connector, square adaptor. CSA approved. Approved to UL standards (NRTL).



- 0120260** Ridgid 700 Drive Installer Package
- 0120261** 1" Adaptor

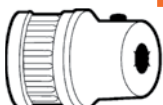

- 0120264** Replacement Brushes
- 0120263** Square Adaptor Assy. (HP71)

Specifications Subject to Change without Notice



Hydraulic Earth Drill



- **Portable:** for one person operation and easy maneuverability
- **Torque Free:** for maximum operator safety and no kick back
- **Hydraulic:** Powerful 11 HP Honda power source is reliable and reversible
- **Versatile:** Fencing, foundations, soil sampling, anchor installation & more



Little Beaver's Hydraulic Earth Drill has a highly maneuverable three-wheel chassis with pneumatic tires, a five-gallon hydraulic reservoir and an 11 HP engine. Patented torque tube eliminates the kickback found on other earth drills, so one-man drilling is safe, fast and productive.

- 0120710** Complete Assembly includes: Little Beaver 11 HP Power Source Anchor Handle Attachment Anchor Adaptor
- 0120700** Power Source
- 0120701** Handle Attachment
- 0120702** Replacement Adaptor

Outdoor Improvements
Anchors & Set-Up Material
Doors & Windows
Coatings & Cleaners
Appliances
Tools & Hardware
Carpet & Flooring
Electrical
Plumbing
Towing & Safety
Heating & Cooling

Portable Building Anchors



For use ONLY on portable buildings and sheds. 5/8" Rods

- 0120305** 30", 5/8" Shaft, 4" Single Disc
- 0120303** 30", 4", 5/8" Shaft, Double Disc
- 0120309** 20", 4", 5/8" Shaft, Single Disc, No Plate

Not stocked at all locations **0120305**

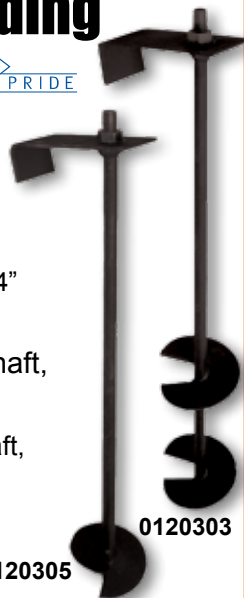

Barbed Anchors

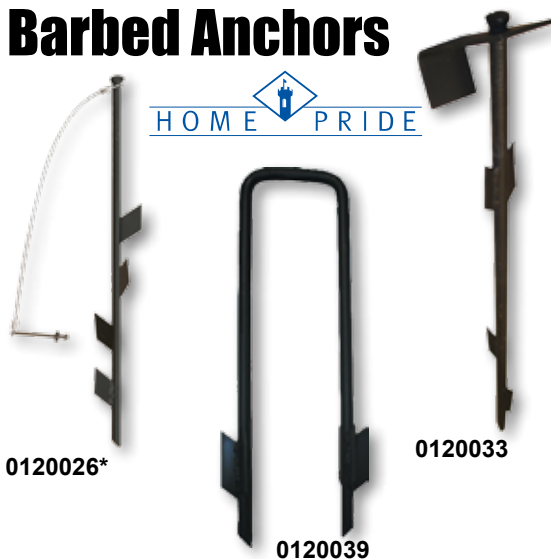
0120026*

0120033

0120039

* Note: Head on 0120026 not welded to shaft of anchor

- 0120026*** 24" for Rock, 3/4" Shaft, 200/Skid
- 0121026** Same as 0120026, but Galvanized
- 0120024** 26" with Cable & Lag, 5/8" Shaft
- 0120032** 34" for Coral with Head, 3/4" Shaft
- 0120033** 30" for Asphalt, 3/4" Shaft, HP9-A, 200/Skid
- 0120034** 30" for Asphalt with Bolt Hole, 3/4" Shaft, 2 Hole Bracket
- 0120039** 24" U-Shaped Barb Anchor

Not stocked at all locations

Shed Anchor Kit

Minute Man anchors, Inc.

Four Eye Anchors
15" Long,
w/ 3" Disk and 50' of
500 lb. test cable.

0120306 Shed Anchor Kit

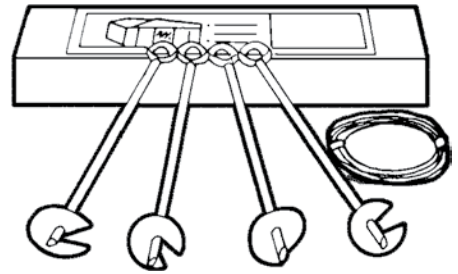

Shed Anchor Kit

A necessity for wind protection with thousands of uses.

Each kit contains:

- 4 30" eye anchors with 4" helix
- 4 1/8" galvanized clamps
- 60' 1/8" galvanized aircraft cable



0120298 Shed Anchor Kit
0120480 Eye Anchor Only

Eye Anchor



Shaft: 5/8" Eye: 1-1/2"

- 0120101** 48" L; 6" Single Disc
- 0120102** 30" L; 4" Single Disc
- 0120115** 30" L; 4" Disc
- 0120021** 30" L; Double 4" Discs
- 0120044** Length: 5/8" x 36"

0120035 Bolt Set – includes:
2" Fender Washers, 1/2" Nut,
4-1/2" x 1/2" Hex Hd Bolt

0120120 Eye Anchor Adapter



AC Pad Anchor System

Easy to install. No cables. No special tools. Great theft deterrent. Two anchors plus Tek screws included with system.

0120040 AC Pad Anchor System

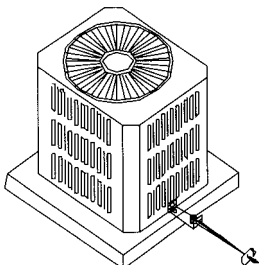

PolyVulc

Soil Test Probe Kit



Determines soil conditions below the surface near the anchor's helical plate. Provides maximum anchor holding strength by insuring the use of the proper anchor for each soil condition. Complete with carrying case, torque wrench, wrench adapter and instructions.

0120321

Minute Man anchors, Inc.

Pocket Penetrometer

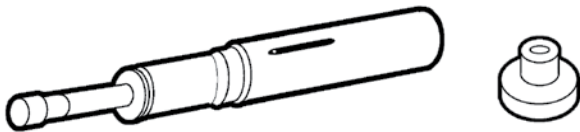

Direct-reading scale in tons/square feet. Ground and polished stainless-steel loading piston. Calibrated spring and penetrometer body plated for rust-resistance and long life. Complete with convenient belt-loop carrying case.

0120322 Penetrometer
0120323 Foot



PolyVulc Pier Pad

Lightweight, heavy-duty recycled materials, superior drainage. Reduces Worker's Comp. claims. New design is **stronger** than ever with more surface area to distribute weight evenly for greater pier spacing so you need fewer pads! Answer to **new regulations** calling for larger footprint pad for heavier homes.



Cost efficient: costs LESS and is stronger than stacking THREE of the competitor's pads to handle the same weight. 100% recycled composite materials.



0265440 16" x 16" x 1"; 15/Bundle; 405/Skid
0265444 17" x 23" x 1"; 15/Bundle; 240/Skid
0265431 18.5" x 18.5" x 1"; 15/Bundle; 270/Skid
0265432 20" x 20" x 1"; 15/Bundle; 270/Skid
0265448 24" x 24" x 1"; 15/Bundle; 160/Skid

Specifications Subject to Change without Notice

ABS Oval Foundation Pads

For use on mobile, manufactured homes, and modular housing. Patent #5503500 and other Patents Pending

Benefits: Easy Installation, Cost Efficient, Thicker, Lighter, and Stronger, Maximize Time and Areas of Labor, Saves On Shipping and Handling, Made from Recycled Materials



17" x 22" Oval Pad Shown

Item #	Oval Pad Size	Max. Load Capacity (lbs.)
0265205	16" x 18.5"	6,000
0265206	17" x 22"	7,500
Special Order	17.5" x 22.5" (Oklahoma Pad)	8,000*
0265208	17.5" x 25.5"	9,000*
0265209	21" x 29"	12,000*
0265210	23.25" x 31.25"	9,388*

* Concrete blocks are only rated at 8,000 pounds. 8,000 lbs and higher must be double blocked.

ABS Square Foundation Pads

For use on all mobile and manufactured homes, including HUD approved homes and modular housing. Patent #5503500 and other Patents Pending

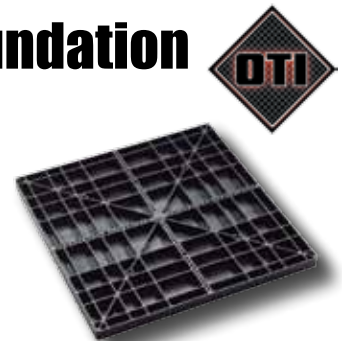

Benefits: Same As Above
24" x 24" Square Pad Shown

Item #	Square Pad Size	Max. Load Capacity (lbs.)
0265200	16" x 16"	5,333
Special Order	13" x 26"	2,375
0265202	18.5" x 18.5"	7,100
0265203	20" x 20"	8,250*
0265204	24" x 24"	8,000*

* Concrete blocks are only rated at 8,000 pounds. 8,000 pounds and higher must be double blocked.

ABS Foundation Pad®



- Bigger, thicker, stronger and better
- Lighter than concrete, saves labor
- Larger pads to increase spacing, by up to 12% saving time and material on pier sets
- Easily stackable for larger pad area and wider pier spacing
- Triple stack for 4, 5 & 6 Sq. Ft. to maximize pier spacing

0265445 16" x 22.5" x 2.5 sq ft
0265446 17" x 25" x 3 sq ft
0265447 16" x 18" x 2 sq ft
0265448 24" x 24" x 4 sq ft

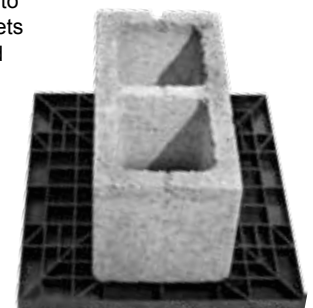

Outdoor Improvements
 Anchors & Set-Up Material
 Doors & Windows
 Coatings & Cleaners
 Appliances
 Tools & Hardware
 Carpet & Flooring
 Electrical
 Plumbing
 Towing & Safety
 Heating & Cooling

Minute Man anchors, Inc.

Longitudinal & Lateral Stabilizing Systems

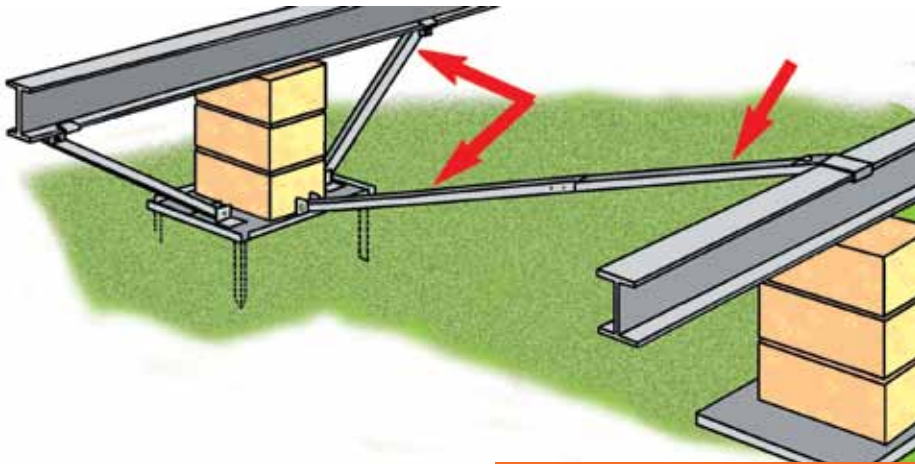

Top-quality heavy gauge steel throughout system

Versatile: provides combined lateral and longitudinal support, or only lateral, or only longitudinal

Flat pad design installs easily, eliminates digging and driving foundation pad into ground

Exceeds requirements for all wind zones. Eliminates frame ties and stabilizers, saving time and money.

- Versatile: provides combined lateral and longitudinal support, or only lateral, or only longitudinal
- Flat pad design installs easily, eliminates digging and driving foundation pad into ground
- Top quality, heavy gauge steel provides stability
- Utilizes adjustable tubing for structural integrity with less inventory
- Easy to install and neatly packaged for warehousing and transport

Lateral Longitudinal

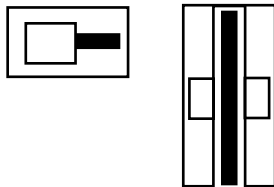

Lateral/Longitudinal

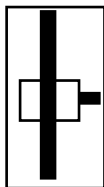

Minute Man anchors, Inc.

Longitudinal System

Zone 1	Zones 2 & 3
0120355 39"*	0120397 39"*
0120356 44"*	0120398 44"*
0120357 53"*	0120399 53"*

* Refers to the length of the bracing tube

Longitudinal system includes the following, as needed for proper zone:

- 20" Galvanized Steel Pad
- Beam Clips w/Hardware
- 1.5" Square Bracing Tubes

Lateral/Longitudinal System

Zone 1	Zones 2 & 3
0120377 39"*	0120373 39"*
0120378 44"*	0120374 44"*
0120379 53"*	0120375 53"*

* Refers to the length of the bracing tube

Lateral/Longitudinal system includes the following, as needed for proper zone:

- 20" Galvanized Steel Pad
- 60" Adjustable Lateral Tube w/Hardware
- Beam Clips w/Hardware
- 2 - 1.5" Square Bracing Tubes

Lateral System

0120370 Lateral System

Not stocked at all locations

Lateral system includes the following:

- 1 - 20" Galvanized Steel Pad
- 1 - 60" Adjustable Lateral Tube with Hardware

Replacement Pins for Pan Systems

0120368 16" Pin

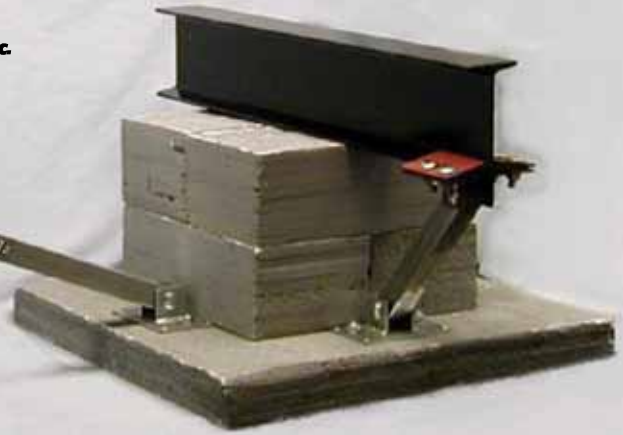

Concrete Dry Set Longitudinal System

includes:

- 2 - 0120346 Dry Set Flanges and Hardware
- 2 - 0120350 Beam Clips With Hardware
- 2 - 1.5" Square Bracing Tubes

- 0120385** 39" Dry Set Longitudinal System
- 0120386** 44" Dry Set Longitudinal System
- 0120387** 53" Dry Set Longitudinal System

Wet Set Longitudinal System

includes:

- 2 - 0120347 Wet Set Flanges and Hardware
- 2 - 0120350 Beam Clips With Hardware
- 2 - 1.5" Square Bracing Tubes

- 0120388** 39" Wet Set Longitudinal System
- 0120389** 44" Wet Set Longitudinal System
- 0120390** 53" Wet Set Longitudinal System

60" Lateral Dry Set System

includes:

- 1 - 0120346 Dry Set Flange and Hardware
- 1 - 0120349 60" Lateral Tube and Hardware

- 0120395** Lateral Dry Set System Assy.
- 0120340** Lateral Dry Set System Assy. (for Missouri)

60" Lateral Wet Set System

includes:

- 1 - 0120347 Wet Set Flange and Hardware
- 1 - 0120349 60" Lateral Tube and Hardware

- 0120396** Lateral Wet Set System Assy.

Guide to Components for Longitudinal & Lateral Stabilizing Systems

These are the components of the assemblies on these two pages. You do NOT need to order them separately, but the following part numbers and descriptions are provided for your information.



0120350
Beam Clip (bottom of beam) with Bolts & Nuts

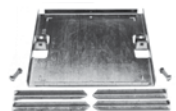

20" Galvanized Steel Pier Pad
0120358 w/16" Drive Pins
0120368 16" Pins

0120320 Replacement Hardware Pack

Hardware Pack Contains:

- (2) 2" x 7-3/4" Lateral Clamps (top of beam)
- (2) 1-5/8" x 2" Tube Clamps
- (4) 1/2" x 2-1/2" Bolts & Nuts
- (2) Instruction Sheets

- (2) 1/2" x 1-1/2" Bolts & Nuts
- (2) 1/2" x 1-3/8" Washers
- (8) 1/4" x 3/4" Self Drilling Screws

0120346 3534 Mark MMCAF Dry Set:
1 - Concrete Anchor Flange: MMCAF
1 - 1/2" x 1-1/2" Carriage Bolt and Nut
2 - 5/8" x 3" Shield Anchors

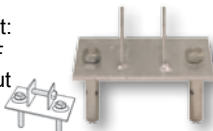

0120347 3536 Mark MMCFW Wet Set:
1 - Concrete Anchor Flange: MMCFW
1 - 1/2" x 1-1/2" Carriage Bolt and Nut



0120349 60" Adjustable Lateral Tube With Hardware (3530)

- 0120352** 39" L. Square Bracing Tube
- 0120353** 44" L. Square. Bracing Tube
- 0120354** 53" L. Square Bracing Tube
- 0120359** 65" x 1.5" Square Bracing Tube (Optional)



VECTOR SYSTEM LATERAL STABILIZATION FOR CONCRETE

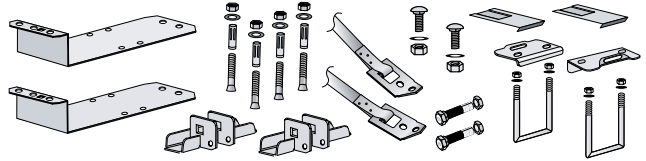
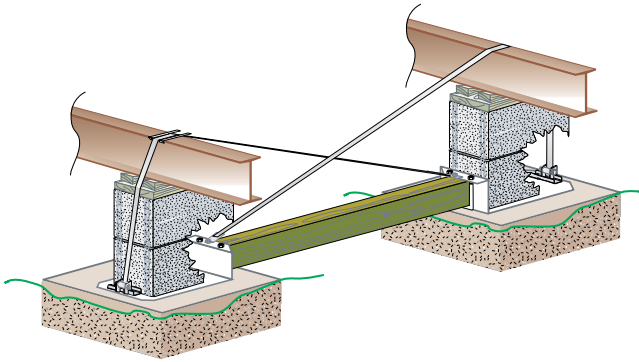

0120441 - Single block pads with hardware, swivel straps and slotted bolts.

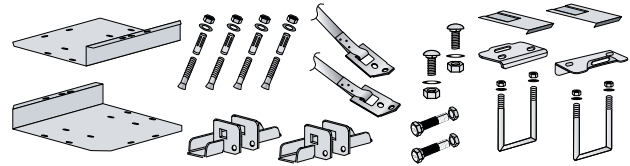
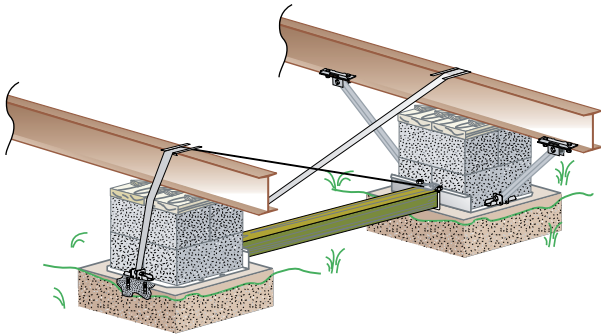

0120440 - Double block pads with hardware, swivel straps and slotted bolts.

Longitudinal Stabilization Hardware Kit for Concrete

0120477 - Includes 2 beam clamps, tension brackets, nuts and bolts.

For use with 0120440 & 0120441, (longitudinal struts not included)

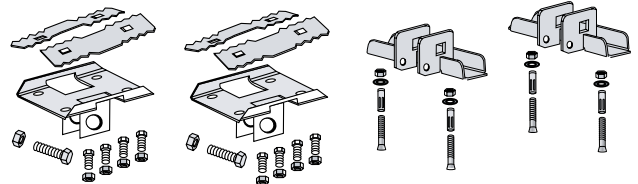

Struts for Longitudinal Systems

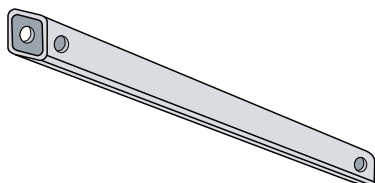

STRUTS FOR LONGITUDINAL SYSTEMS

PART NO.	LENGTH	PIER HEIGHT
0120473	30"	up to 2 Blocks
0120445	39"	up to 3 Blocks
0120446	44"	up to 4 Blocks
0120447	53"	up to 5 Blocks
0120448	65"	up to 6 Blocks



Foundation Systems Component Parts List

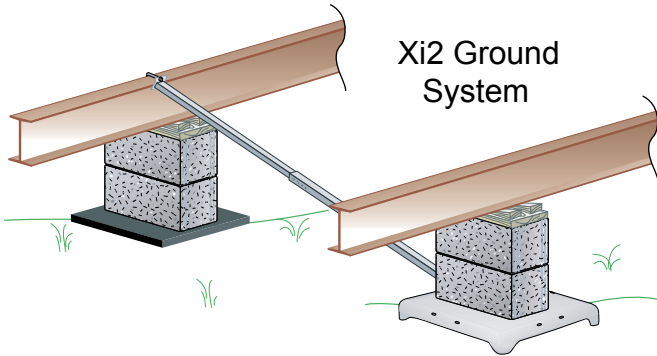

Xi2 Ground System

Xi2 Ground Systems

Includes:
5' Strut
Pad
Hardware

0120487

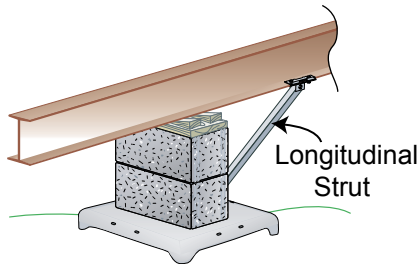

Longitudinal Strut

Longitudinal Struts for "Ground Systems"

Part No.	Length	Pier Height
059330-30	30"	up to 2 Blocks
059330-39	39"	up to 3 Blocks
059330-44	44"	up to 4 Blocks
059330-53	53"	up to 5 Blocks
059330-65	65"	up to 6 Blocks

Special Order Only

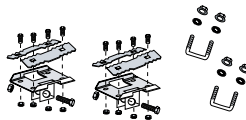

Ground Longitudinal Hardware Kit

Longitudinal Hardware Kit

0120489 (Includes 2 sets per kit: I-beam brackets, U-bolt, nuts, bolts and washers)

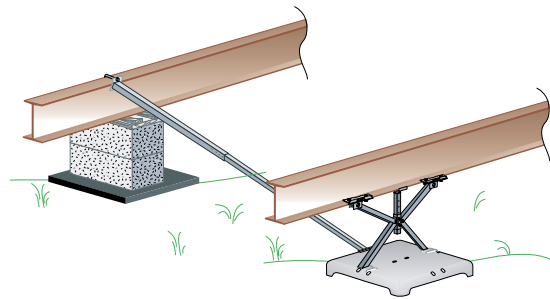

Xi System with Xi Steel Pier

- 0120498 - Xi, 12" steel Pier, & Longitudinal System
- 0120490 - Xi, 25.5" steel Pier, & Longitudinal System
- 0120494 - Xi, 36" steel Pier, & Longitudinal System

Steel Piers can be combined with one of the following for lateral support:

- 0120491 - Xi, Lateral Strut, 5' w/hardware
- 0120496 - Xi, Lateral Strut, 5' w/hardware - GA
- 0120495 - Xi, Lateral Strut, 6' w/hardware
- 0120497 - Xi, Lateral Strut, 6' w/hardware - GA
- 0120488 - Xi Steel Pier Hardware Kit

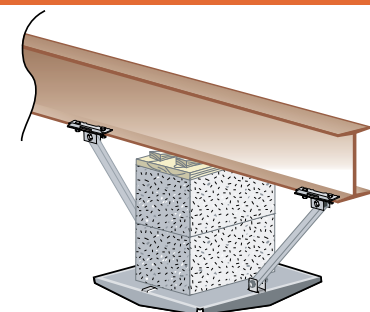

3 Sq. Ft. Pad Vector Longitudinal System

Includes 2 beam clamps, 2 tension brackets, nuts & bolts.

Struts for Longitudinal System on Page B-10

- 0120442 - 3' Vector Pad
- 0120478 - Longitudinal Hardware



All Steel Foundation Systems

Versions of the ASF Systems are available for every wind zone

Systems can be purchased to offer lateral protection, or lateral & longitudinal protection

Systems are available for pre-poured concrete sets, and pre-existing concrete sets

Cost Efficient

Longitudinal system eliminates 2 piers

Approved for use with most home manufacturers

Eliminates Most Frame Anchors

Eliminates 2 Piers

Lateral System



Wind Zone 1

- ◆ 0120525 1100 ITV Lateral Pan System
- ◆ 0120526 1100 ITCV Wet Concrete Lateral Pan System
- ◆ 0120527 1100 ITCV Dry Concrete Lateral Pan System

Lateral & Longitudinal System



For Complete System Add Appropriate Conversion Kit & Tube To Above Lateral System

Wind Zone 1 & 2

- ◆ 0120460 Longitudinal Pan Conversion Kit
- ◆ 0120462 Longitudinal Wet Concrete Conversion Kit
- ◆ 0120461 Longitudinal Dry Concrete Conversion Kit

Longitudinal Tubes (2 req.)			Longitudinal Tubes (2 req.)		
Zone 1 & 2	Size	Pier Height	Zone 1 & 2	Size	Pier Height
0120582	20"	14" - 18"	0120585	44"	30" - 40"
0120583	28"	18" - 25"	0120586	54"	36" - 48"
0120584	39"	24" - 35"			

North Carolina Lateral System



Wind Zone 1

- ◆ 0120530 NC-1100 ITV Lateral Pan System
- ◆ 0120531 NC-1100 ITCV Wet Concrete Set
- ◆ 0120532 NC-1100 ITCV Dry Concrete Set

Wind Zone 1 & 2

For Complete System Add Appropriate Conversion Kit & Tube To Above Lateral System

- ◆ 0120460 Longitudinal Pan Conversion Kit
- ◆ 0120464 Wet Set Concrete Conversion Kit
- ◆ 0120463 Dry Set Concrete Conversion Kit

N. Carolina Long. Tubes (2 req.)			N. Carolina Long. Tubes (2 req.)		
Zone 1 & 2	Size	Pier Height	Zone 1 & 2	Size	Pier Height
0120587	20"	14" - 18"	0120590	44"	30" - 40"
0120588	28"	18" - 25"	0120591	54"	36" - 48"
0120589	39"	24" - 35"			

ASF Florida System



- ◆ 0120533 Lat./Long. Pan System - Less Longitudinal Tubes
- ◆ 0120537 Lat./Long. Wet Concrete System - Less Long. Tubes
- ◆ 0120538 Lat./Long. Dry Concrete System - Less Long. Tubes
- ◆ 0120534 Long. Pan System - Less Longitudinal Tubes
- ◆ 0120535 Long. Wet Concrete System - Less Tubes
- ◆ 0120536 Long. Dry Concrete System - Less Tubes

Florida Long. Tubes (2 req.)			Florida Long. Tubes (2 req.)		
Zone 1 & 2	Size	Pier Height	Zone 1 & 2	Size	Pier Height
0120575	14"	12" - 18"	0120578	44"	33" - 41"
0120576	22"	17 ³ / ₄ " - 25"	0120579	54"	40" - 48"
0120577	32"	24 ³ / ₄ " - 33"			

ASF Michigan System



- ◆ 0120592 Dry Concrete Hardware Kit
- ◆ 0120580 5' Lateral Arm

ASF Georgia System



- ◆ 0120539 Lateral Pan System

All Steel Foundation System Replacement Parts



All Steel Foundation Systems

Part #	Parts Description	Pallet Qty.
0120366	Bolt Bag for Longitudinal System	Bag Each
0120367	Extended I-Beam Clamp (1100-9xP)	
0120582	20" Longitudinal Arm (Painted)	4/Bndl. Each
0120583	28" Longitudinal Arm (Painted)	4/Bndl. Each
0120584	39" Longitudinal Arm (Painted)	4/Bndl. Each
0120585	44" Longitudinal Arm (Painted)	4/Bndl. Each
0120586	54" Longitudinal Arm (Painted)	4/Bndl. Each
0120625	5' Lateral Arm (Painted)	2/Bndl. Each
0120632	20" Longitudinal Arm (Galvanized)	4/Bndl. Each
0120633	28" Longitudinal Arm (Galvanized)	4/Bndl. Each
0120634	39" Longitudinal Arm (Galvanized)	4/Bndl. Each
0120635	44" Longitudinal Arm (Galvanized)	4/Bndl. Each
0120636	54" Longitudinal Arm (Galvanized)	4/Bndl. Each
0120626	5' Lateral (Galvanized)	
Part #	Florida Replacement Parts	
0120637	18" x 1.5" Telescoping Arm	
	To be used with one of the following arms	
	Part #	Longitudinal Tubes
	0120638	14" x 1.25" Longitudinal Tube
	0120639	22" x 1.25" Longitudinal Tube
	0120640	32" x 1.25" Longitudinal Tube
	0120641	44" x 1.25" Longitudinal Tube
	0120642	54" x 1.25" Longitudinal Tube

Adjustable Outrigger



- ◆ Costs less than perimeter blocking under doors and windows
- ◆ Unaffected by frost heave
- ◆ Eliminates problems with anchor spacing
- ◆ Easy to install
- ◆ Never interferes with skirting
- ◆ Doors easily adjusted
- ◆ Never settles
- ◆ Tested and approved
- ◆ D.A.P.I.A. approved

0120280 14" Wide
0120281 16" Wide