

Kinro VINYL WINDOWS

VINYL WINDOW FEATURES

Vinyl construction provides high thermal performance in vertical and horizontal windows.

Frame and sash corners are welded for added strength and water tight corners.

Frame designed with multiple hollow areas for maximum strength and energy efficiency.

Window sash can be removed for easy cleaning on any level of the home.

Reinforcement bars in the meeting rails provide added strength.

Positive integral lock at the meeting rail for increased home security and weather resistance.

Dual weather seal to reduce drafts and enhance energy efficiency.

Nominal 3/4" insulating glass provides superior thermal performance.

Integral "J" trim eliminates the need for additional exterior frame accessories and covers the raw edge of the siding for a clean appearance.

Deep pocket sill for added window strength and weather resistance.

Integral lift rail for easy sash operation.

Spiral balance system provides near effortless sash operation.



Kinro Inc. reserves the right to change details or sizes without notice. The customer assumes all risk for alterations made to Kinro products. All Kinro primary window products are laboratory tested to meet or exceed all manufactured housing federal specifications as labeled on each window. AAMA 1701 compliant for Housing and Urban Development (HUD) codes. AAMA 101 compliant for residential building code requirements. Able to meet Energy Star requirements in all 50 states.

Kimro VINYL WINDOWS

Exact Window Size W x H	Window w/Screen	With 6 x 6 Grids	Obscure Glass W/Screen	w/Super Saver Argon Gas	Low E	Low E Obscure Glass W/Grids	Low E With 6 x 6 Grids
14" x 21"	0462805				0462804		
14" x 27"	0462750		0462797	0462950	0462749		
14" x 35-3/4"	0462847						
14" x 36"	0462777						
14" x 39-5/8"	0462833			0462951	0462860	0462933	
14" x 40"	0462751		0462798				
14" x 53"	0462829				0462826		
14" x 53-7/8"	0462778						
18" x 27"					0462818		
18" x 39-5/8"					0462819		
24" x 39-5/8"	0462834	0462820		0462952	0462879		
24" x 40"	0462752	0462737					
30" x 27"	0462753	0462738		0462953	0462862		
30" x 30"	0462780						
30" x 35-3/4"	0462837	0462822		0462954	0462901		
30" x 36"	0462754	0462739					
30" x 39-5/8"	0462839	0462824		0462955	0462864		
30" x 40"	0462755	0462740			0462904		
30" x 52"	0462806						
30" x 53"	0462756	0462757		0462956	0462883		
30" x 53-7/8"	0462807	0462741					0462916
30" x 58"	0462783						
30" x 68"	0462808						
36" x 27"	0462785						
36" x 35-3/4"	0462851				0462856		
36" x 36"	0462786						
36" x 39-5/8"	0462852				0462857		
36" x 40"	0462787						
36" x 53"	0462842			0462957	0462870		
36" x 53-7/8"	0462758	0462742			0462887		
40" x 27"	0462788						
40" x 39-5/8"	0462854				0462858		
40" x 40"	0462789						
40" x 53-7/8"	0462790						
46-1/4" x 27"	0462791				0462792		
46-1/4" x 30"					0462794		
46-1/4" x 39-5/8"	0462843	0462828		0462958	0462891		
46-1/4" x 40"	0462759	0462743					
46-1/4" x 53"	0462845			0462959	0462892		
46-1/4" x 53-7/8"	0462760	0462744			0462876		0462927
62" x 40"	0462795						



- Vertical and Horizontal Slider Windows.
- Multiple fixed open positions.
- Bulb vinyl seal on sliding insert and vinyl sealed interlocking meeting rail for excellent weatherization.
- Pile weather-stripping in sliding rail for long-lasting seal.
- Removable spring loaded screen.
- Pre-punched mounting holes.
- All standard mobile home sizes available.
- Mill or painted frame.



Pocahontas Aluminum windows meet or exceed all applicable test criteria set forth in AAMA 1702.2-02 and applicable ASTM standards for weatherization and optional structural performance for Wind Zone III (155 mph) as referenced in CFR 3280.305©. This testing included an Air Infiltration Test, Water Resistance Test, Structural Performance Test (Exterior and Interior Pressure), and an Optional Increased Structural Performance Test.

PAC windows also passed structural loading at +/- 85 PSF (184.5 MPH and 16" H²O).

Obscure Glass Bathroom Windows

Obscure glass makes these windows perfect for bathrooms or any room where you want light and privacy.



Vertical slider-type window with obscure glass, perfect for bathrooms. Mill finish.

0462572 14" x 27"



Obscure glass, economical choice for bathrooms. 36" x 8" mill finish.

0462594 Window (does not open)

Horizontal Slider Windows

Call Size* Width X Height	Mill Finish	White Self-Storing Storm Windows
30" x 30"	0462526	
30-1/4" x 14-7/16"	0462590	0462636
46-1/4" x 27-1/16"	0462593	
46-1/4" x 39-5/8"	0462505	0462624

- Call Width + 1/2" for Rough Opening
- Other sizes available by special order.

NOTE:
For vinyl bath windows, see
Kinro's Vinyl Window Chart.

Buck Size (Actual Size of Window) Width x Height	White Flush Mount	Mill Flush Mount	White Lap Siding Applications	White Self- Storing Storm	White Re- placement Screen	Mill Replace- ment Screen	Bronze Flush Mount	Actual Screen Size
14-1/4" x 21-3/4"	0462701 0462560*	0462561		0462602				13-9/16 x 10-13/16
14-1/4" x 27-1/16"	0462703	0462524		0462607		0462485		13-9/16 x 13-7/16
14-1/4" x 30"		0462527						13-9/16 x 14-15/16
14-1/4" x 35-3/4"		0462587		0462631				13-9/16 x 17-13-16
14-1/4" x 39-5/8"	0462712	0462559		0462613		0462484		13-9/16 x 19-3/4
14-1/4" x 53-5/16"		0462575		0462634				13-9/16 x 26-7/16
18-1/4" x 21-3/4"		0462589		0462625				17-9/16 x 10-13/16
18-1/4" x 27-1/16"	0462721	0462586		0462628				17-9/16 x 13-7/16
18-1/4 X 30"		0462528						17-9/16 x 14-15/16
18-1/4" x 35-3/4"		0462529						17-9/16 x 17-13/16
18-1/4" x 39-5/8"		0462581		0462617				17-9/16 x 19-3/4
18-1/4" x 53-5/16"		0462530						17-9/16 x 26-7/16
22-1/4" X 27-1/16"	0462722	0462573		0462629				21-9/16 x 13-7/16
22-1/4" x 35-3/4"		0462571						21-9/16 x 17-13/16
24-1/4" x 21-3/4"		0462584		0462626				23-9/16 x 10-13/16
24-1/4" x 24-1/4"		0462569	0462352	0462627				23-9/16 x 12-1/16
24-1/4" x 27-1/16"	0462704 0462564* 0462351**	0462565	0462353	0462600		0462481		23-9/16 x 13-7/16
24-1/4" x 30"	0462700	0462531	0462349					23-9/16 x 14-15/16
24-1/4" x 35-3/4"		0462583		0462632				23-9/16 x 17-13/16
24-1/4" x 39-5/8"	0462713	0462580		0462618				23-9/16 x 19-3/4
24-1/4" x 53-5/16"		0462532				0462699		23-9/16 x 26-7/16
30" x 54"		0462366						29-5/16 x 26-15/16
30" x 66"				0462620				29-5/16 x 32-15/16
30-1/4" x 21-3/4"	0462702	0462579		0462603				29-9/16 x 10-13/16
30-1/4" x 27-1/16"	0462705	0462506	0462354 0462348**	0462601	0462725	0462495	0462543	29-9/16 x 13-7/16
30-1/4" x 30"	0462708 0462733**	0462497	0462356	0462605		0462490		29-9/16 x 14-15/16
30-1/4" x 35-3/4"	0462709	0462563	0462357	0462606		0462482		29-9/16 x 17-13/16
30-1/4" x 39-5/8"	0462714 0462509**	0462507	0462362	0462610	0462726	0462494	0462542	29-9/16 x 19-3/4
30-1/4" x 52-5/16"	0462718	0462508		0462614	0462728	0462487	0462545	29-9/16 x 26-1/16
30-1/4 x 52-5/16								29-9/16 x 26-1/16
30-1/4" x 53-5/16"	0462719 0462723**	0462525	0462367 0462380* 0462350**	0462615	0462729	0462493	0462544	29-9/16 x 26-7/16
30-1/4" x 58-5/8"		0462574		0462623		0462479		29-9/16 x 29-1/4
30-1/4" x 66-1/8"		0462510						29-9/16 x 32-15/16
36-1/4" x 21-3/4"		0462533						35-9/16 x 10-13/16
36-1/4" x 27-1/16"	0462706	0462578		0462608				35-9/16 x 13-7/16
36-1/4" x 30"		0462534						35-9/16 x 14-15/16
36-1/4" x 35-3/4"	0462710	0462577	0462358	0462612				35-9/16 x 17-13/16
36-1/4" x 39-5/8"	0462715	0462522		0462611				35-9/16 x 19-3/4
36-1/4" x 52-5/16"		0462535						35-9/16 x 26-1/16
36-1/4" x 53-5/16"	0462720	0462499		0462616		0462488		35-9/16 x 26-7/16
40-1/4" x 21-3/4"		0462536						39-9/16 x 10-13/16
40-1/4" x 27-1/16"		0462567		0462609				39-9/16 x 13-7/16
40-1/4" x 30"		0462537						39-9/16 x 14-15/16
40-1/4" x 35-3/4"	0462711	0462585		0462633				39-9/16 x 17-13/16
40-1/4" x 39-5/8"	0462716	0462582		0462619				39-9/16 x 19-3/4
40-1/4" x 52-5/16"		0462538						39-9/16 x 26-1/16
40-1/4" x 53-5/16"		0462592		0462635		0462470		39-9/16 x 26-7/16
46-1/4" x 21-3/4"		0462539						45-9/16 x 10-13/16
46-1/4" x 27-1/16"	0462707	0462496		0462604		0462492		45-9/16 x 13-7/16
46-1/4" x 30"		0462588		0462630				45-9/16 x 14-15/16
46-1/4" x 35-3/4"		0462540						45-9/16 x 17-13/16
46-1/4" x 39-5/8"	0462717	0462694		0462621	0462727	0462491		45-9/16 x 19-3/4
46-1/4" x 52-5/16"		0462541						45-9/16 x 26-1/16
46-1/4" x 53-5/16"		0462498	0462368	0462622	0462732	0462489		45-9/16 x 26-7/16

* Windows have 4 x 4 grids

** Windows have 6 x 6 grids

Other sizes available by special order.

Outdoor
Improvements
Anchors &
Set-Up Material
Doors &
Windows
Coatings &
Cleaners
Appliances
Tools &
Hardware
Carpet &
Flooring
Electrical
Plumbing
Towing &
Safety
Heating &
Cooling

Window & Screen Repair

Storm Rail

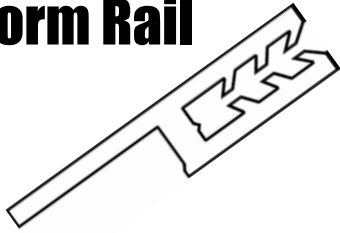

For replacing glass in windows. White PVC in 12' lengths.

0462414 300/Ctn.

Kinro Window Glazing

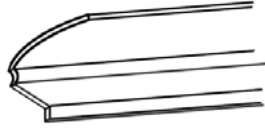

Vinyl strip for holding glass in place when replacing pane. White 12' lengths.

0462410

Glazing Channel

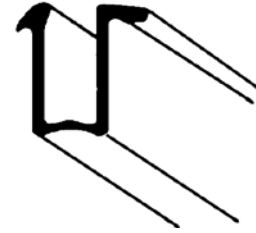

For replacing glass in sliding windows.

0462411 White, 8'

0462413 Black, 12'

Corner Inserts

Plastic screen frame corner inserts 25/Ctn.

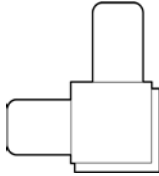

For Metal Frames

0262643 White

0262606 Gray (for Mill)

0262609 Black (for Bronze)

For Vinyl Frames

0262645 White

Screen Springs



Holds window screen in window.

0462428 Each; 250/Ctn.

Storm Window Corner Clip #711

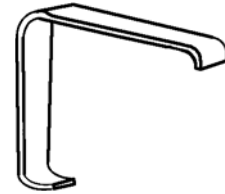

0461599 Each; 25/Ctn.

Aluminum Molding Drip Rail

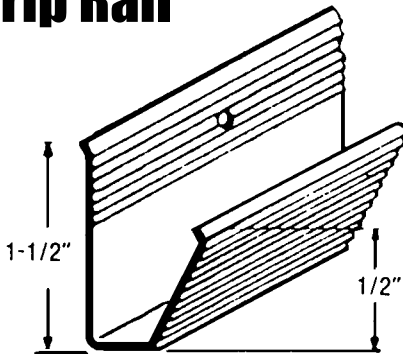

Serrated face 1-1/2" standard 1-1/2" rail 14' length w/punched 4" centers.

0265503 25/Ctn.

Elixir Drip Cap

Install over doors and windows to channel away rain and snow. Steel with white finish.



0212009 For 72" door

0212011 For 32" or less door

0212012 For 34" door

0212013 For 36" door

0212014 For 48" door

0212018 For 53" door

Drip Cap

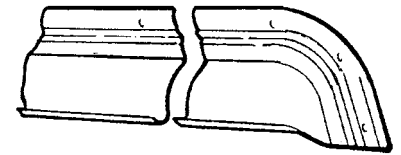

Install over doors and windows to channel away rain and snow. The confined caulking area insures neat appearance and positive seal.

0210950 31"

0210951 35"

0210953 39"

0210954 43"

0210955 49"

Screws

0262653 8" x 3/4"; 10,000/Box



Slider Lock

Fits all metal door & window frames, thumb screw locking. Allows for various vent openings.

0462435

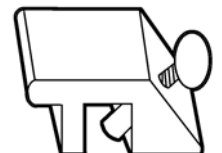

Screen Repair

Storm Window Kits

0462100 38" x 64"
0462102 50" x 80"



Frame Extrusions w/out Spline

Aluminum framing in 16' lengths. Uses 5/32" spline.

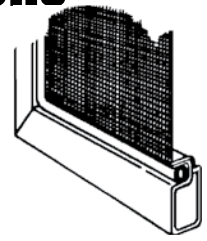

0462425 Bronze
0462426 Mill Finish
0462427 White

Screen Spline

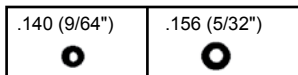

Replacement spline for metal and fiberglass screening.

Gray Spline

0462404 9/64", 20'; 10/Ctn.
0462406 5/32", 20'; 10/Ctn.
0462403 5/32", 1000'

Black Spline

0462407 9/64", 20'; 10/Ctn.
0462408 5/32", 20'; 10/Ctn.
0462409 5/32", 1000'
0462405 9/64", 250'

Screen Frame Kits

Makes a frame for window or door screen.

Kit contains:

- 4 Aluminum Frames
- 4 Corner Connectors
- 2 Pull Tabs
- 1 Spline
- 2 Corner Springs

Additional Items Needed

- Screen
- Screen Installer
- Tape Measure
- Hacksaw to cut frames
- Utility Knife or Scissors



0462330 Up To 36"W x 36"L Frame, White
0462331 Up To 48"W x 48"L Frame, White
0462332 Up To 60"W x 60"L Frame, White

Screen Installer



Use convex roller end of installation tool to roll screen wire into slot of aluminum screen frame. Use concave roller end to roll plastic spline into slot over screen wire to hold it tightly in place.

0462402 5/32"; 10/Ctn.
0462400 1/16"; 10/Ctn.

Fiberglass Screen

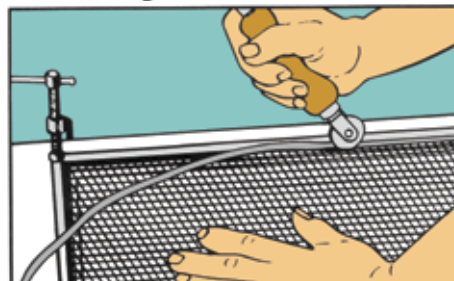

Fiberglass screen with 16 x 16 size mesh. Won't dent, corrode, or stretch. 100' roll.

Gray Screen

0269002 30" x 100'
0269001 36" x 100'
0269004 42" x 100'
0269000 48" x 100'

Charcoal Screen

0269005 30" x 100'
0269008 36" x 100'
0269007 42" x 100'
0269006 48" x 100'

Snap Fasteners

For screens, storm windows and many other holding applications. "Self-serve" colorful display bag punched for easy hanging. Each 3-3/4" x 4" bag contains 4 fasteners complete with screws. Seals windows against drafts.

0462430 36/Ctn.

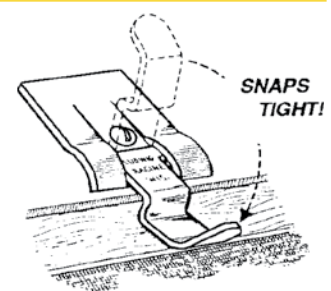

Window Vents

Adjustable Window Screens



2 Ways to Save Energy!

- Easy to use fingertip adjustment fits most sash windows and expands from 20" to 37"
- Provides economical ventilation
- Ideal for windows in your home, RV, cabin, boat or mobile home
- Designed for easy storage when not in use
- Durable fiberglass screening keeps insects out while allowing natural ventilation
- Installs easily without tools from inside.

0462327 15" High, Adjustable 20" to 37" Wide; 12/Ctn.



Window Vent

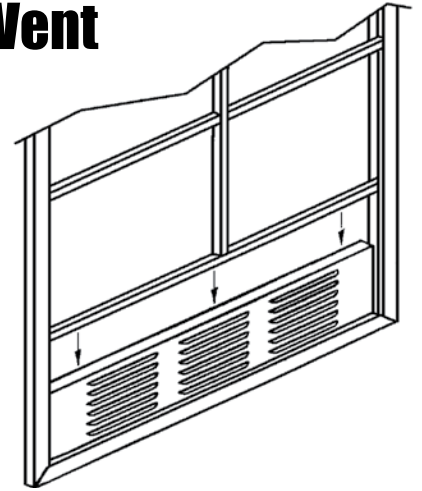

- Easily installed in standard window frames. Just place vent in window track and close window to the top of the vent!
- Multiple louver design provides ventilation without letting in drafts, Insects or weather
- 30" & 46" widths standard (actual: 29-1/2" & 45-1/2")
- Mill finish
- **0462326** 5" High for 30" Windows
- **0462325** 5" High for 46" Windows

Window Blinds

Mini-Blinds



1" PVC, lead-free with wand in classic white sized to fit manufactured housing windows. 10/Ctn.

- 0260500** 32" x 30"
- 0260501** 32" x 56"
- 0260508** 32" x 64"
- 0260502** 38" x 56"
- 0260503** 48" x 56"
- 0260506** 48" x 64"
- 0260507** 35.5" x 54"

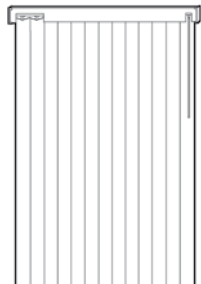

Vertical Blinds

3.5" PVC, lead-free with wand in classic white, perfect for sliding glass doors.

- 0260504** 78" x 84"

Solar Screening

For Quality, Energy Efficient Screens: A fiberglass screen crafted to block up to 75% of the sun's rays entering a building. Reduces air conditioning costs and prevents fading of furniture and carpets indoors. Will shade exposed patios, decks, sliding doors and windows. Available in Charcoal color.

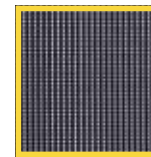

100' ft. Rolls - Solar Screening
(1 Roll/Polybag Packaging)

Stock #	Width
0269025	30"
0269026	36"
0269027	48"
0269035	48" (90%)



Window Replacement Parts

#800K Operator Kit

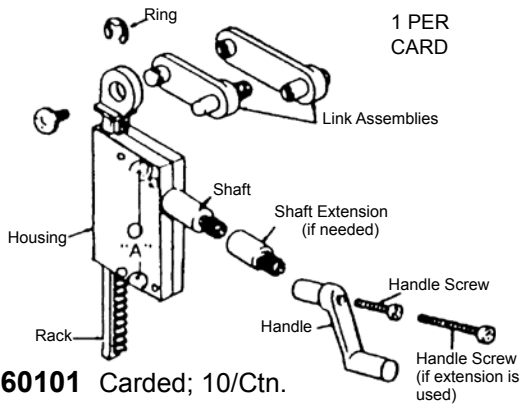

1 PER CARD

0460101 Carded; 10/Ctn.

#801K Operator Kit

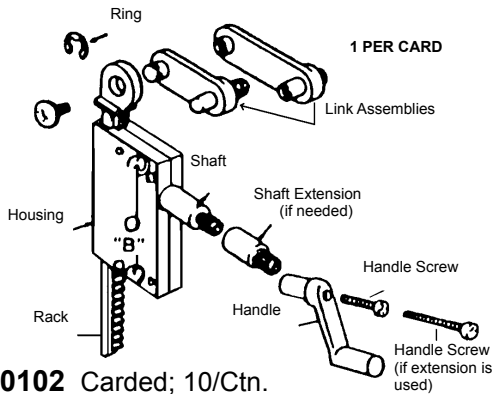

1 PER CARD

0460102 Carded; 10/Ctn.

#816 Rack Operator

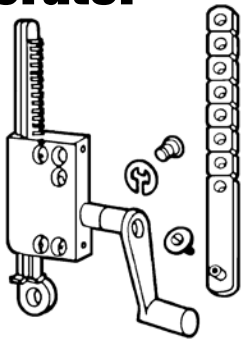

0461701 Carded; 10/Ctn.

#747 Awning Type R.H. Operator

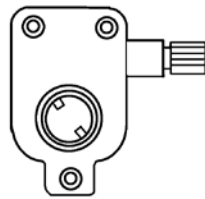

0461804 Skin Packed; 10/Ctn.

#1712 R.H. Operator

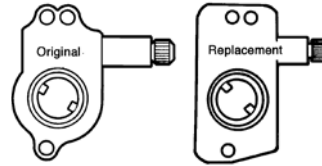

0461825

#808 Side Mount Operator

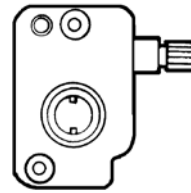

RH
0460201 Skin Packed; 10/Ctn.
0460203 25/Bag

LH
0460202 Skin Packed; 10/Ctn.
0460204 25/Bag

#761 Slant Sill Operator - RH

0461109 Skin Packed; 10/Ctn.
0461822 25/Bag

#762 Slant Sill Operator - LH

0461818 Skin Packed; 10/Ctn.
0461819 25/Bag

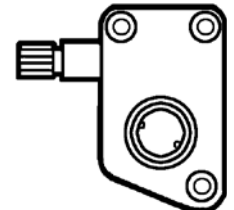

(LH Shown)

#735 Side Mount Operator

R.H.
0461106 Skin-Packed; 10/Ctn.
0461105 25/Bag

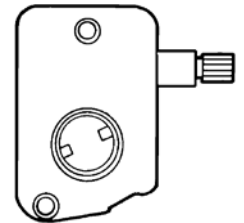

#715 Side Mount Operator

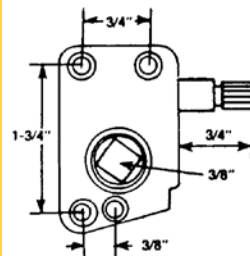

R.H.
0461816 25/Ctn.

#733 Side Mount

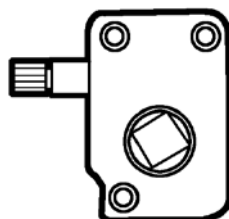

0461815 R. H. Poly-bagged; 25/Ctn.

#787 Side Mount

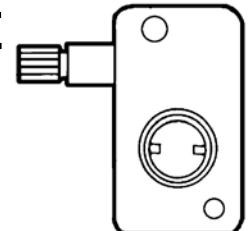

R.H.
0461802 Skin-Packed; 12/Ctn.
0461803 25/Bag

Window Replacement Parts

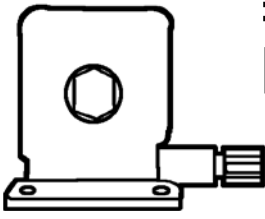

#802 Center Mount

0460402
 Hex 3/8";
 Skin-Packed; 12/Ctn.

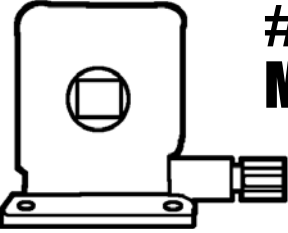

#811 Center Mount 1/4"

0460401 Square 1/4";
 Skin-Packed;
 12/Ctn.

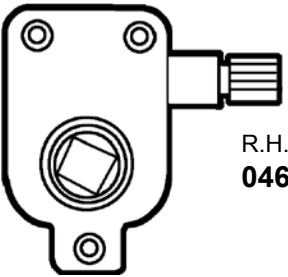

#749 Awning Type

R.H.
0461807 Skin-Packed; 10/Ctn.

#758 Side Mount

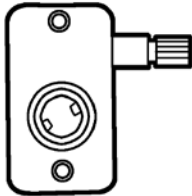

0462639
 R. H.; 25/Ctn.

#490 Flat Nylon Wing Clip

Six clips w/screws per pack.
0461602 Skin-packed; 10/Ctn.



#492 Plastic Clip - Flat

Six clips w/screws per pack.
 Flat offset.

0461603 10/Ctn.



E-Rings



8 #328C per card

0461845 1/4"

C-32

#812 Center Mount 5/16"

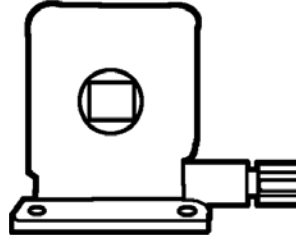

0461831
 Square 5/16"; 25/Bag

#803 Center Mount

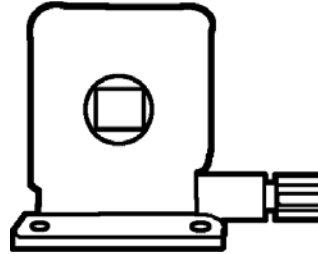

0460403
 R.H. Square 5/16";
 Skin-Packed; 12/Ctn.

#751 Side Mount

0460404
 R. H.; 25/Ctn.

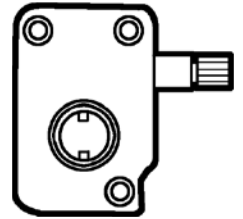

#498 Offset Plastic Clip



Six clips w/screws per pack. 3/8" offset. 10/Ctn.

0461604

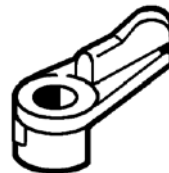

#495 Plastic Clip

Six clips w/ screws per pack. 3/16" offset.
 10/Ctn.

0461832

#350 Metal Zee Clip

Six clips w/screws per pack.
 Carded; 10/Ctn.

0461601



Window Replacement Parts

#760 Torque Bar Bearing

0460310 Metal, Bulk; 25/Ctn.

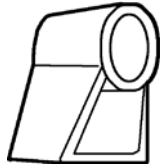

#719 Torque Bar Bearing

0460300 25/Ctn.

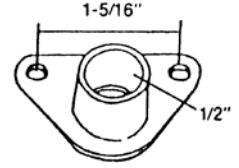

#845 Torque Bar Bearing

0461838 Metal, Bulk; 25/Ctn.



#738 Torque Bar Bearing

0460308 Nylon, Bulk; 25/Ctn.



#74 Nylon Torque Bearing

0460302 10/Ctn.

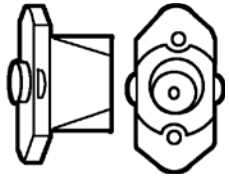

#70 Nylon Torque Bearing

0460301 10/Ctn.

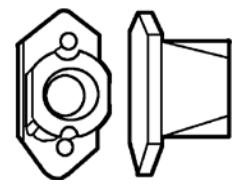

Plastic Knob Handle

D=1/2" Knob, Carded; 10/Ctn.

0461839

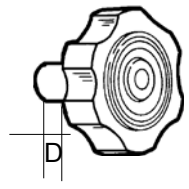

#763 Nylon Torque Bar Bearing

0461598 Bulk; 25/Ctn.

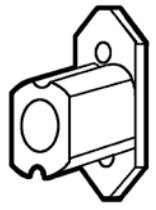

Crank Handles w/Screws

Plastic Crank Handles		
Prod. No.	Size	Quantity
0461833	1"	25/Bag
0461834	1-3/4"	25/Bag
0461823	2-1/2"	600/Ctn.
0461204	2-1/2" Carded	10/Ctn.
0461205	3-3/16" Carded	10/Ctn.
0461206	3-3/16"	500/Ctn.

Metal Crank Handles		
Prod. No.	Size	Quantity
0461201	1" Carded	10/Ctn.
0461200	1"	750/Ctn.
0461202	1-3/4" Carded	10/Ctn.
0461203	1-3/4"	500/Ctn.
0461827	3-1/2" Carded	10/Ctn.
0461826	3-1/2"	350/Ctn.

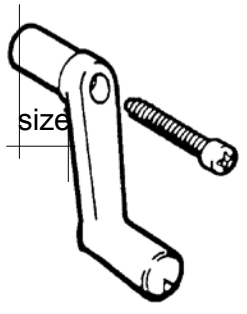

Metal Extension for Crank Handle

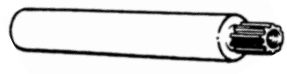

- 0461301 1/2"
- 0461303 7/8"
- 0461304 2"

Carded; 10/Ctn.

Screws for Crank Handle

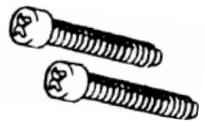

0461208 2-1/2"; 100/Ctn.

Window Hinges

Sold in pairs only; 10/Ctn.

Stock#	WCM#	"A"	"B"	"C"	"D"	"E"	"F"
0461001	786C	3/16"	2-3/16"	3-1/8"	7/16"	3-3/4"	W/Stud
0461101	835P	3/16"	2-3/16"	3-1/8"	1"	4-3/8"	W/Stud

